

OPERATION & MAINTENANCE MANUAL

Launcher LCH-W723 3D Wheel Aligner

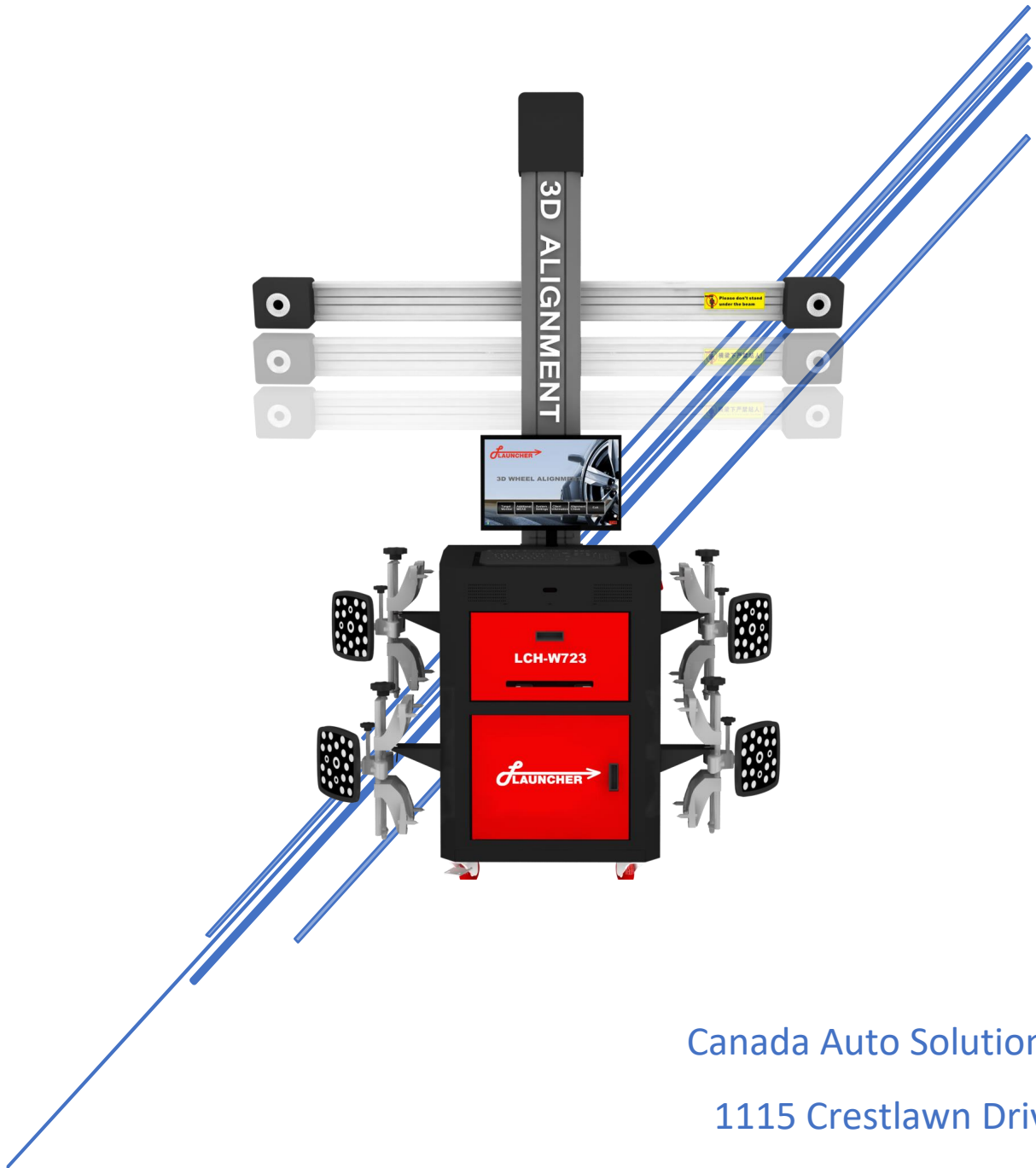

Canada Auto Solutions

1115 Crestlawn Drive

Mississauga Ontario Canada

905-602-0226



Copyright Information

Copyright ©2009~2013. All rights reserved. No part of this publication may be reproduced, stored in a retrieval system, or transmitted in any form or by any means, electronic, mechanical, photocopying, recording or otherwise, without the prior written permission of our company. The information contained herein is designed only for the use of this unit. We are not responsible for any use of this information as applied to other units.

Neither we nor our affiliates shall be liable to the purchaser of this unit or third parties for damages, losses, costs, or expenses incurred by purchaser or third parties as a result of: accident, misuse, or abuse of this unit, or unauthorized modifications, repairs, or alterations to this unit, or failure to strictly comply with our operating and maintenance instructions.







We shall not be liable for any damages or problems arising from the use of any options or any consumable products other than those designated as our Original Products.

1 Precautions

- Please read the User's Manual and the Installation and Parts Manual carefully before operating our 3D Series Wheel Aligner.
- Only the qualified technician can operate the Wheel Aligner.
- The operator must have knowledge of computer application and basic theory of wheel alignment.
- The power voltage of 3D series wheel aligner is AC110~240V±10% 50±1Hz / 60±1Hz. **The power outlet must be a Three PIN socket and its earth pin must be well grounded.** If the power voltage is not stable, please purchase and use AC voltage stabilizer.
- 3D series wheel aligner is operated with image sensing; by analyze target images recorded by high-resolution video camera. Avoid reflect Infrared light or direct sun light to the targets.
- 3D series wheel aligner is high precision equipment; special care should be taken during installation and operation to prevent the casing from being distorted and the internal parts from being damaged.
- Install the lift according to the lift specifications before installing 3D series wheel aligner. Check the lift regularly for fixedness and levelness to ensure personal safety and correct measurement. Remove the obstacles around the lift for convenient operation.
- Don't place 3D series wheel aligner on a vibrated object or an oblique surface. Avoid direct sunlight and moisture.
- Avoid splashing water on the surface of 3D series wheel aligner, for it may cause permanent damage to the system.

- The targets are major components for wheel alignment, be careful in storage or operation. Clean the dirt with neutral detergent or ethanol.
- Accurate calibration is made during manufacturing, and the design doesn't require calibration work for a few years, install 3D series wheel aligner according to the user/installation manual. Do **NOT** move the column, open or adjust cameras, or else the warranty is expired automatically, and end user will bear the cost of damage.
- Video cameras are high precision parts; the filters shall be kept clean.
- Turn off the power after operation. Check all bolts and parts after maintenance and tighten the slackened bolts and parts in turn for safety.
- Check the packing list before installing. Do not hesitate to contact us or our distributors for any questions.

2 General Safety Instructions

-  The chassis measurement system may only be used to measure vehicle axles according to specifications.
-  Only trained professional may operate the system.
-  Safety equipment may not be removed and/or disabled.
-  Repairs may only be performed by trained customer service personnel. Arbitrary modifications of the system exclude any liability by our company for any resulting damages.
-  Any work on the electrical installation may only be performed by electricians.
-  The wheel aligner system may not be operated in explosion- prone surroundings.
-  The operator must provide appropriate fire protection measures at the measuring platform. In particular, any flammable or self- combusting items (such as cloths soaked in solvents or oil) and fluids, or foreign items and other ignition sources, should not be stored in the tool trolley.

Obligation by the operator to be considerate and avoid negligent acts:

The equipment was designed and constructed with consideration to required harmonized standards, as well as additional technical specifications. It therefore corresponds with the current state of technology and provides the maximum standard in safety during the operation.

The machine safety, however, can only be implemented during the operation, if all of the required steps have been taken. The operator of the machine has the obligation to plan these actions and check their compliance.

The operator must specifically verify that:

- The machine is only used according to specifications.
- The machine is only operated in perfect operational condition and that the safety equipment is routinely inspected as to their operational condition.
- The necessary personal safety equipment for operating, maintenance and repair personnel is available and being worn.
- The operating instructions are always in a legible condition and are completely available at the machine location.
- The machine is only operated, maintained and repaired by qualified and authorized personnel.
- These personnel are instructed routinely in all pertaining questions of work safety and environmental protection, and knows the operating instructions, especially the safety instructions contained therein.
- All safety and warning labels attached to the machine are not removed and are legible.

3 Concrete safety instructions and applied symbols

Concrete safety instructions are provided in the following operating instructions which will point out any unavoidable remaining risks during the machine operation. These remaining risks contain hazards for:

- *Persons*
- *Product and machine*
- *The environment*

Basic safety measures during normal operations:

The machine may only be operated by trained and authorized personnel who know the operating instructions and capable of working with the equipment!

Prior to switching the machine on, check and verify that:

Only authorized personnel are located within the working range of the machine.

No one can be injured when the machine is activated!

Check the machine for visible damages prior to use and verify that it is only operated in perfect condition!

Report any problems immediately to the supervisor!

Prior to each operating start, check and verify that all safety equipment operates perfectly!

Basic safety measures during service and maintenance:

Adhere to the inspection and maintenance intervals specified in the operating instructions!



Block access to the work area of the machine to unauthorized personnel prior to performing maintenance or repairs! Attach or set up a warning sign that points out maintenance or repair work!



Pull the power plug prior to any maintenance or repair work or switch off the main switch for the power supply and secure with a lock, if the power supply is installed.

The key to this lock must be in the hands of the person that is completing the maintenance or repair work! Only use perfect load suspension and lifting equipment when replacing heavy machine parts!



Properly dispose of environmentally hazardous lubricants, coolants or cleaning agents!

Working on the electrical equipment:



Repairs on electrical equipment of the machine may only be performed by trained electricians!

Re-attach any loose connections!

Immediately replace damaged lines/cables!

Always keep housings of electrical equipment closed! Access is only permitted for authorized personnel with key/tools!

Never spray the housing of electrical equipment with a hose when cleaning!

Observe environmental regulations:



The legal regulations for waste prevention and proper recycling/disposal must be adhered to for all operations on and with the machine.

Especially during installation, repair and maintenance operations, water-polluting materials, such as: Lubricants and oils - hydraulic oils - coolants.

Solvent-containing cleaning liquids may not pollute the ground or reach the sewage system!!

These materials must be stored, transported, collected and disposed of in suitable containers!

Table of Contents

Copyright Information	i
1 Precautions	ii
2 General Safety Instructions.....	iii
3 Concrete safety instructions and applied symbols	iv
Chapter 1 Introduction.....	1
1. 1 Definition	1
1. 2 When wheel alignment will be needed.....	1
1.3 Major alignment parameter.....	1
1. 3. 1 Camber	2
1. 3. 2 Toe-in	2
1. 3. 3 Steering Axle Inclination	3
1. 3. 4 Caster.....	3
1. 3. 5 Toe-out on turn.....	4
1. 3. 6 Thrust Angle	4
1. 3. 7 Wheelbase diff.	5
1. 3. 8 Track Width Diff.....	5
1. 3. 9 Left (right) lateral offset (angle)	5
1. 3. 10 Axle Offset (angle).....	5
1. 3. 11 delay (angle).....	6
1. 3. 12 Included angle.....	6
1. 4 Function and feature.....	6
1. 5 Tech Specs	7
1. 6 Requirements on Surroundings.....	7
1. 7 Working Principle.....	8
Chapter 2 Hardware Structure	1
2. 1 Overall Structure	1
2. 2 Target and Clamps.....	2
2. 3 Communication Cable.....	2
2. 4 Turntable and passing bridge.....	2
2. 5 Steering wheel holder	3
2. 6 Brake pedal depressor	3
Chapter 3 Basic Operation Procedure.....	1
3. 1 Precheck	1
3. 1 Alignment Measurement	1
3. 3 Adjustment.....	1
3. 4 Test Run.....	1
Chapter 4 Operation Instruction.....	2
4. 1 Preparation before test.....	2
4. 2 Software Operation	2
4.2.1 Alignment Check	3

4. 2. 2 System Settings	9
4. 2. 3 General Settings	14
4. 2. 4 Print Report.....	15
4. 2. 5 Help Information.....	16
4. 2. 6 Exit Software.....	16

Chapter 1 Introduction

1.1 Definition

3D series wheel alignment system is to test wheel parameters and provide reference of manufacturer specs, by compare the two set of parameters, operator can adjust the vehicle wheel parameters to reasonable range, make the vehicle wheels in good condition and avoid unreasonable tire worn.

1.2 When wheel alignment will be needed

At the following circumstance, wheel alignment will be necessary:

- Vehicle pull to one side when release steering wheel.
- Uneven tire worn.
- Steering wheel too heavy, too light or shake when driving at high speed.
- After tire change, chassis parts replacement.
- After collision.
- After 3000 km's drive of new car.
- At regular vehicle maintenance.

1.3 Major alignment parameter

Wheel alignment angles are relative angle of the chassis parts, which makes the vehicle running stable and reduce tire worn.

Major wheel alignment angle include: Camber, Toe, Caster, SAI, Toe-out on Turn.

1. 3. 1 Camber

Camber is the leaning of the wheel inwards or outwards from the vertical. If the road wheel leans outwards from the vertical, it has positive camber and when leaning inwards from the vertical - negative camber, looking from the front or rear of the vehicle. See Fig.1.1. Camber is measured in degrees. Without camber, the wheels will tilt to the inside at full load; increase the possibility of uneven tire worn. Hence, this parameter can extend the life of tire and related axis.

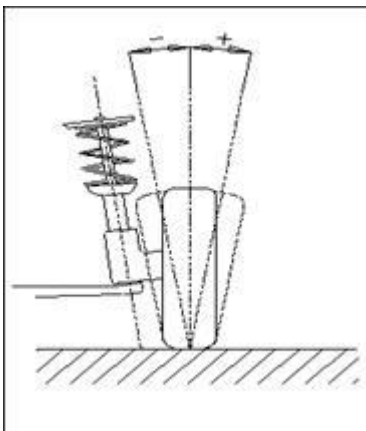

Figure 1.1

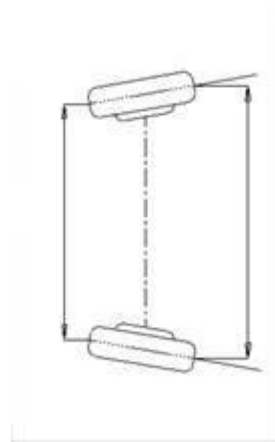

Figure 1. 2

1. 3. 2 Toe-in

The toe setting is the amount by which the front or rear wheels point inwards or outwards at the front of the wheel in relation to each other (see Fig.1.2). When the wheels point inwards they are said to toe-in. Toe-in figures are given a positive value. Conversely when the wheels point outwards, they are toe-out and the figures are shown as a negative value.

The purpose of correct toe is to ensure that the wheels run parallel when the vehicle is driving. An incorrect toe setting may affect the stability and controllability of the vehicle.

1. 3. 3 Steering Axle Inclination

Steering Axle Inclination (SAI) is the angle of steering axis and vertical line (vehicle front view). As shown in Figure 1.3. Correct Kingpin Inclination can equalize the loads applied on bearings so that the life of bearings can be prolonged and the controllability of steering is improved. Without the inclination, the controllability of the steering may be affected; furthermore, the vehicle weight and the ground counterforce may cause significant stress in the axle and finally damage the axle. Correct inclination of king pin is also helpful for the vehicle to restore its straight-ahead position after steering. Kingpin Inclination is determined when the vehicle suspension is designed. It is not service adjustable.

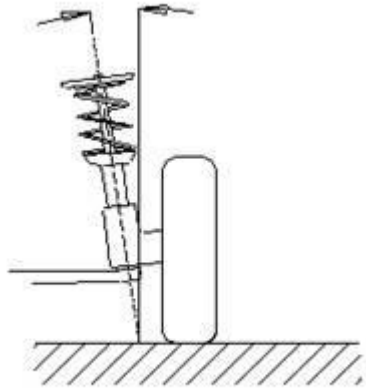

Figure 1. 3

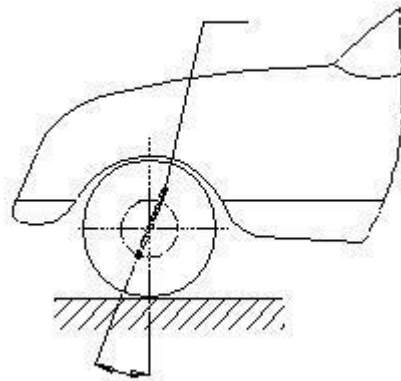

Figure 1. 4

1. 3. 4 Caster

Caster is the tilting of the kingpin either forwards or backwards from vertical, as viewed from side of the vehicle. See Figure 1. 4. When the king pin is tilted backwards from the vertical, caster is positive. When the king pin is tilted forwards, caster is negative. Caster angle influences the directional stability of the steering. To increase the tendency of the steering to self-centre, the steering will normally be designed with positive caster. Normally caster angle of a vehicle is between 1~4 degrees.

1. 3. 5 Toe-out on turn

Toe-out on turns is defined as the difference of the steering angle between the two front wheels when turning left or right by 20°. see Figure 1.5. When the vehicle turns, the inner wheel angle is always bigger than the outer wheel, difference is about 2 degrees, the purpose is to make the vehicle turn by referenced to the instant center point of the extend line of back axis.

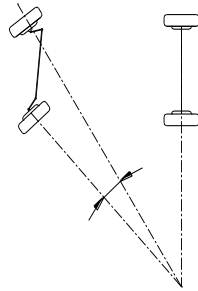

Figure 1. 5

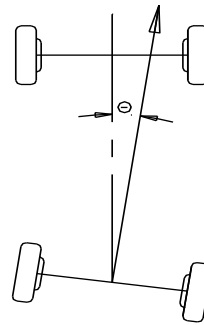

Figure 1. 6

1. 3. 6 Thrust Angle

Definition: The angle between the vehicle's centerline and the vehicle thrust line. When driving, the front wheels and the rear wheels should pull to the same side if the thrust angle is not zero. When thrust line is at the left side of the vehicle's centerline, the thrust angle is positive, otherwise is negative. The existence of the thrust angle causes the vehicle's rear body pull to one side. In order to drive the vehicle straight-ahead, the front wheels have to turn to the direction of thrust line. If thrust angle compensation is not done for front toe, the steering wheel must be turned to one side when driving straight-ahead. If rear toe can be adjusted, the thrust angle should be adjusted close to zero. The direction of thrust line is the actual driving direction of the vehicle, which is determined by rear toe. When the direction of thrust line doesn't coincide with the geometric centerline of the vehicle, the steering wheel must be turned by some degrees to keep the vehicle driving straight-ahead, so that unbalance phenomenon of the steering wheel is caused. At the same time, the traveling paths of rear wheels don't coincide with that of front wheels. This kind of phenomenon is called Rear Wheel Lateral Move. If ignore the thrust line, the veracity of alignment cannot be ensured. This is the main reason of the steering deflection. If you select the thrust line as the measurement datum, you can perform the following operation procedures: □ After adjusting rear toe to the specified value (OEM Specifications), the thrust line will coincide with the vehicle's centerline. For the vehicle with adjustable rear suspension, rear toe should be adjusted to keep the thrust angle close to zero. □ No matter the thrust angle is zero or not, the steering wheel can be adjusted balanced if you take the thrust line as alignment datum. If rear toe cannot be adjusted, please adjust front toe, and keep it be same with rear toe, and then set them to the angle by which the steering wheel can be balanced.

1. 3. 7 Wheelbase diff.

Wheelbase difference is defined as the angle between the joint line of the center of two rear wheels and that of the front wheels. It is positive when distance between the center of the right wheels is large than that of left wheels; and negative otherwise. If the tread is available from the vehicle specifications, then the wheelbase difference can be also expressed by angle. See Figure. 1.7.

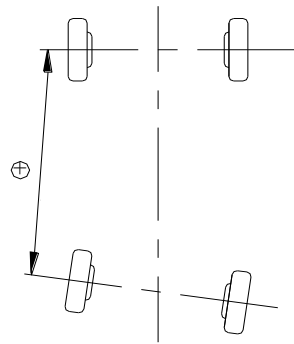

Figure 1. 7

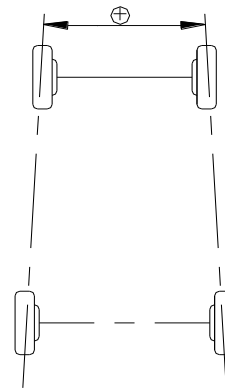

Figure 1. 8

1. 3. 8 Track Width Diff.

Track width (Tread) difference is defined as the angle between the joint line of the ground-contact point of left wheels and that of the right wheels. It is positive when distance between the center of the rear wheels is large than that of front wheels; and negative otherwise. If the wheelbases are available from the vehicle specifications, then the tread difference can be also expressed by angle. See Figure 1.8.

1. 3. 9 Left (right) lateral offset (angle)

The offset of rear left (right) wheel and front left (right) wheel at the vehicle's lateral direction. When rear left (right) wheel is outside of front left (right) wheel, left (right) lateral is positive, otherwise, it's negative. The angle between the trust angle and the left (right) front/back wheel center line is the left (right) lateral offset angle.

1. 3. 10 Axle Offset (angle)

The relative offset of front axle and rear axle at the vehicle's lateral direction is defined as Axle offset. When rear axle is more to the right side than front axle, axle offset is positive, otherwise, it's negative. The angle between the center line of the difference angle and the trust angle is defined as axle offset angle.

1. 3. 11 delay (angle)

The same axle's relative offset in longitudinal direction of the vehicle is called the delay. When the right wheel is behind of the left wheel on the same axle, the delay is positive, otherwise, it's negative. The angle between the wheel center line and the vehicle longitudinal geometric center line vertical is called the delay angle.

1. 3. 12 Included angle

The sum of Kingpin inclination angle and camber angle is called the included angle.

1. 4 Function and feature

- All new three-dimension computer visual measurement: adopted high performance camera to automatically detect the alignment parameter. The equipment was calibrated at production, does not need on-site calibration at installation.
- Electric component free target: no electric component or wiring on the target, which ensure the equipment to be more convenient and durable.
- 3D (Fixed Height) wheel aligner can be installed at any height according to user's interest.
- 3D (Auto Focus) wheel aligner can detect the lift position and follow the lift up and down, to ensure the equipment always in best working height.
- Extremely simplified test procedure.
- Complete parameter measurement: Capable of test of front/rear toe-in, front/rear camber, thrust angle, caster, SAI/Kingpin, wheelbase, track (thread) etc.
- Large database: More than 20000 records of vehicle all over the world, and user can add data at will.
- Historical data storage for client management.
- Real-time help system.

1.5 Tech Specs

Power Supply:	AC 110/220V 50/60 Hz
Computer Host:	Lenovo/Dell (or all in one computer)
Monitor:	18. 5 inch color monitor (all in one computer comes with 23 inch monitor)
Toe-in	0~+_20 degree.
Camber	0~+_8 degree.
SAI/Kingpin	0~+_20 degree.
Caster	0~+_20 degree.
Thrust Angle	0~+_5 degree.
Rim diameter	10 ~ 23 inch

Caution

- ***WE preserve the right to change design without prior notification.***
- ***The measure range can only be assured when operate the wheel aligner according to this user manual.***

1. 6 Requirements on Surroundings

Ambient temperature:0~50°C

Relative humidity: ≤85%

Light condition: No direct Infrared light to the targets

Lift platform height difference: front/end height difference < 2mm

1. 7 Working Principle

3D series wheel aligner working principle is as shown in figure 1. 9. The entire system can be divided into two categories: data acquisition and data processing.

Figure 1. 9

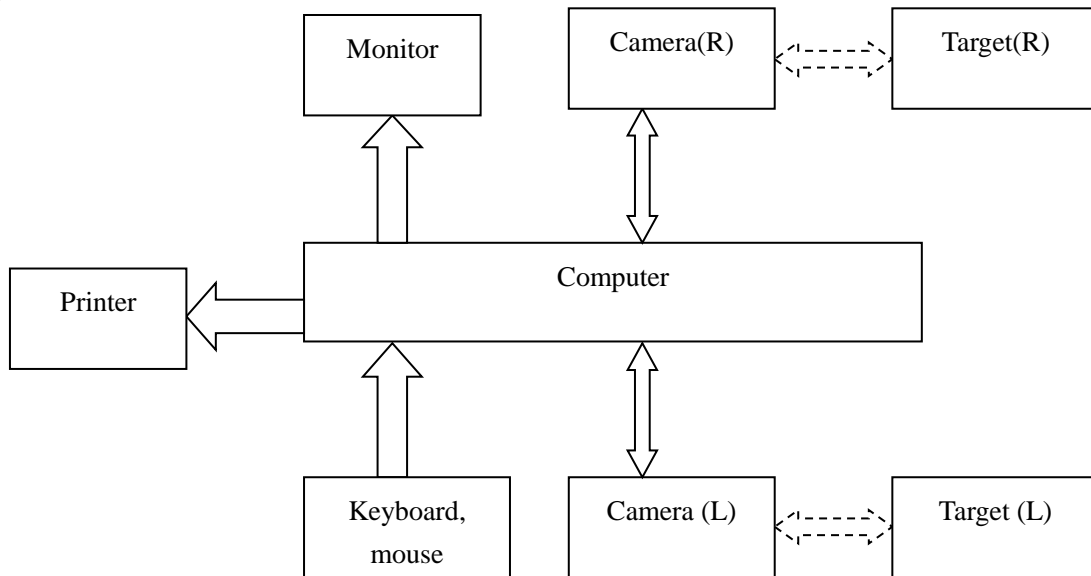

Data acquisition category consists of 2 high definition cameras and 4 targets. Left and right side camera get target image and send to data processing citatory. Target was mounted onto the wheel via clamps.

Data processing category is the core component of 3D wheel aligner, consist of computer system, power supply system and interface. The function is to realize operator's instruction, automatically guide the measurement, and calculate data and display together with manufacture data, at the same time, guide the operator to do adjustment on the vehicle. Finally, print out the report.

Since 3D series wheel alignment system need to compare tested data with manufacturer data, and provide guidance of adjustment, database is very important to provide reference data. 3D series wheel aligner database covers over 20000 records of vehicle data worldwide. At the same time, 3D series wheel aligner system provides function for operator to input and save customized data.

Chapter 2 Hardware Structure

2. 1 Overall Structure

3D series wheel aligner consists of column assembly, lateral beam assembly (include 2 sets of camera assembly), cabinet, computer host, monitor, printer, targets, clamps, communication cables, turntables, steering wheel holder, brake pedal depressor etc. as shown in Figure 2. 1.

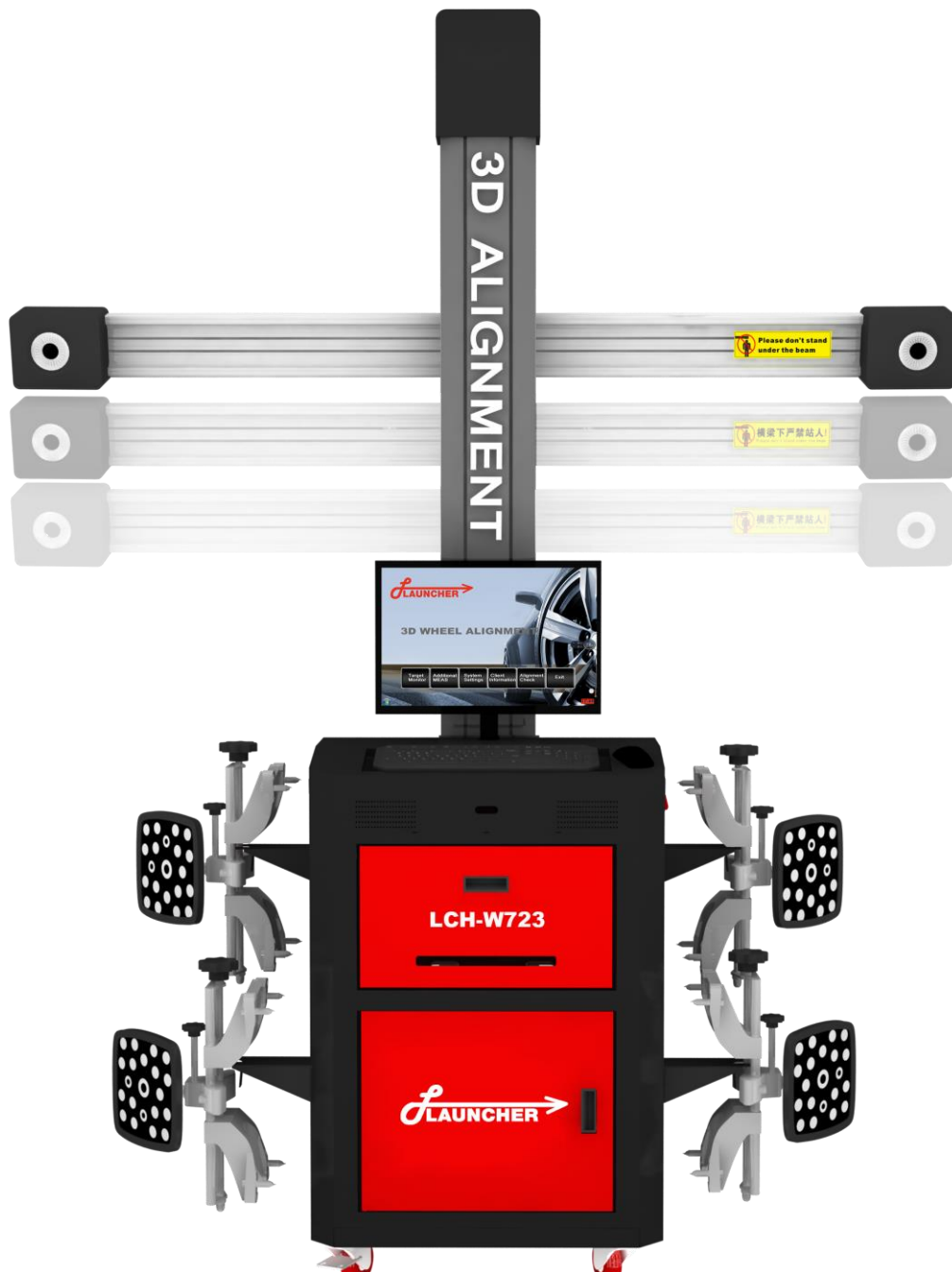

3D Series Wheel Aligner

2. 2 Target and Clamps

3D series wheel aligner has 4 targets (come together with 4 clamps), is a key component for acquire raw data of wheel alignment (Figure 2. 2), Cameras will capture target image for data processing. On the back of the target, there's identification label for target position.



Figure 2. 2

2. 3 Communication Cable

3D series wheel aligner has two cables between computer and lateral beam, one is USB data cable, another one is power supply cable, shall keep them in good condition to avoid damage to the entire alignment system.

2. 4 Turntable and passing bridge

3D series wheel aligner comes with 2 mechanical turntables, as shown in figure2. 2. Turntable shall be placed on the front wheel position on the lift, each turntable has a passing bridge, to ensure vehicle move smooth when do rolling compensation.



Figure 2. 3

2. 5 Steering wheel holder

3D series wheel aligner equipped with a steering wheel holder, as shown in figure 2. 4. The steering wheel holder is mainly used when do rolling compensation.



Figure 2. 4

2. 6 Brake pedal depressor

3D series wheel aligner equipped with a brake pedal depressor, as shown in figure 2. 5. it's used to press down the brake pedal, to prevent vehicle from moving at certain measurement stage, e.g., caster swing.



Chapter 3 Basic Operation Procedure

3. 1 Precheck

Ask the owner for vehicle drivability problems, symptoms, and wheel alignment history, and find out vehicle information such as make, model and year, etc. Check each chassis part carefully, include dust cover, bearing, rock arm, tripod-ball, shock absorber, tie rod ball and steering mechanism, for any loose or wear. Then check to see if the tire pressure, tire treads of the left and right wheels are alike. Perform the wheel alignment checking after the initial condition is known. If the measuring values do not accord with the specifications given in the databank, the wheel alignment should be adjusted. After finishing the wheel alignment, test the vehicle to see if the abnormal conditions are eliminated. Re-adjust the wheel alignment if necessary.

3. 1 Alignment Measurement

After precheck, can start alignment measurement.

3. 3 Adjustment

In the alignment measurement, based on the measurement results, combined with the actual vehicle alignment fault phenomena, with reference of the OEM specs, to make corresponding adjustments according to the actual situation.

3. 4 Test Run

The vehicle shall be test derived, after alignment adjustment, to confirm if the fault phenomena are eliminated. Otherwise, shall redo the adjustment.

Chapter 4 Operation Instruction

4. 1 Preparation before test

- 1) Ask the owner for vehicle drivability problems, symptoms, and wheel alignment history, and find out vehicle information such as make, model and year, etc.
- 2) Check and lock turntables and side slip plates, place the passing bridge, drive the vehicle onto the lift, make front wheel about to be on the turntable center. When the vehicle well on desired position, center the steering wheel, lock the steering wheel with steering wheel holder. Place the parking rubber at back wheel, then release handbrake. Lift the vehicle up to the alignment height.
- 3) Check each chassis part carefully, include dust cover, bearing, rock arm, tripod-ball, shock absorber, tie rod ball and steering mechanism, for any loose or wear. Then check to see if the tire pressure, tire treads of the left and right wheels are alike.
- 4) Mount the clamps and target onto the wheels, and lock the clamps.
- 5) Power up the wheel aligner computer.

4. 2 Software Operation

Switch on power, boot the computer, then the wheel alignment software will automatically start.

There are 6 function buttons on the main interface: alignment check, System Settings, General Settings, Print Report, help, exit. As shown in Figure 4. 1.



Figure 4. 1

4.2.1 Alignment Check

Click [Alignment check] at main interface to start alignment procedure.

4.2.1.1 Select Vehicle

Before alignment measurement, reference vehicle data shall be selected, as shown below:

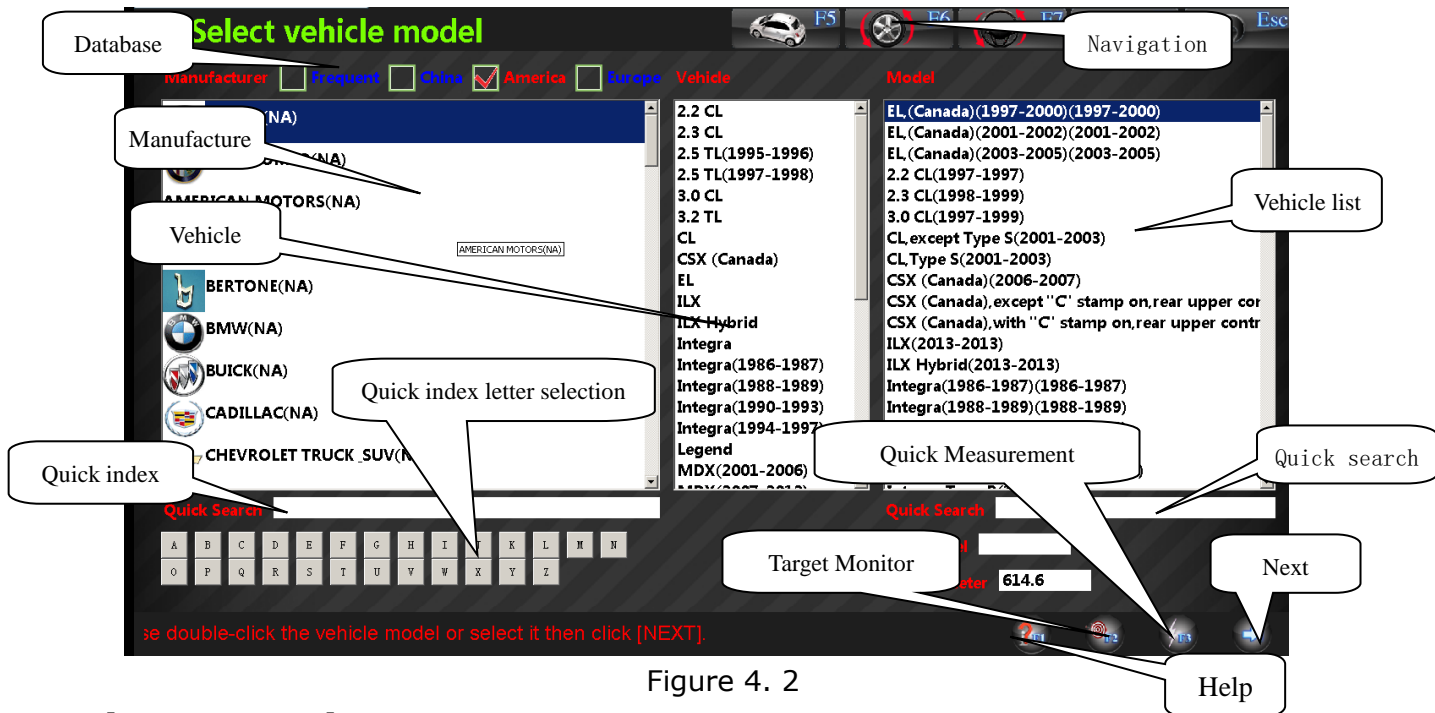

Figure 4. 2

[Navigation Bar]

Can access to independent measurement steps instead of follow the default sequence.

[Database selection]

Can select data record from different database category. If it's the first time to use Frequently Used Specs, the list shall be empty, need to import from OEM specs at [main interface] ->Frequently Used Specs.

[Manufacturer, Vehicle list]

Select the desired vehicle by navigating the list, click and continue the measurement.

[Quick index letter selection area]

Quick index manufacturer by inputs the letters.

[Quick vehicle index]

At the bottom of the screen, quick index is provided. E.g. KIA, click 'K' 'I' 'A' or input 'KIA' with keyboard, to fast allocate the vehicle make.

[Help Information]

Help system and tips for the current page.

[Target Monitor]

Can find out the reason in target monitor screen when system prompt target blocked. Also, can adjust the lateral beam height manually in this screen.

[Quick Measurement]

If exit program accidentally after rolling compensation, can access quick measurement, but the result might be a bit inaccurate.

[Next]

To make the measurement follow the default sequence (select vehicle->rolling compensation->Caster swing->report print).

4.2.1.2 Push Compensation

Push Compensation is to eliminate the error caused by the physical defect of rim and tire as well as the installation of clamps. Accuracy level could be higher after eliminate these errors. As shown in the follow graph:

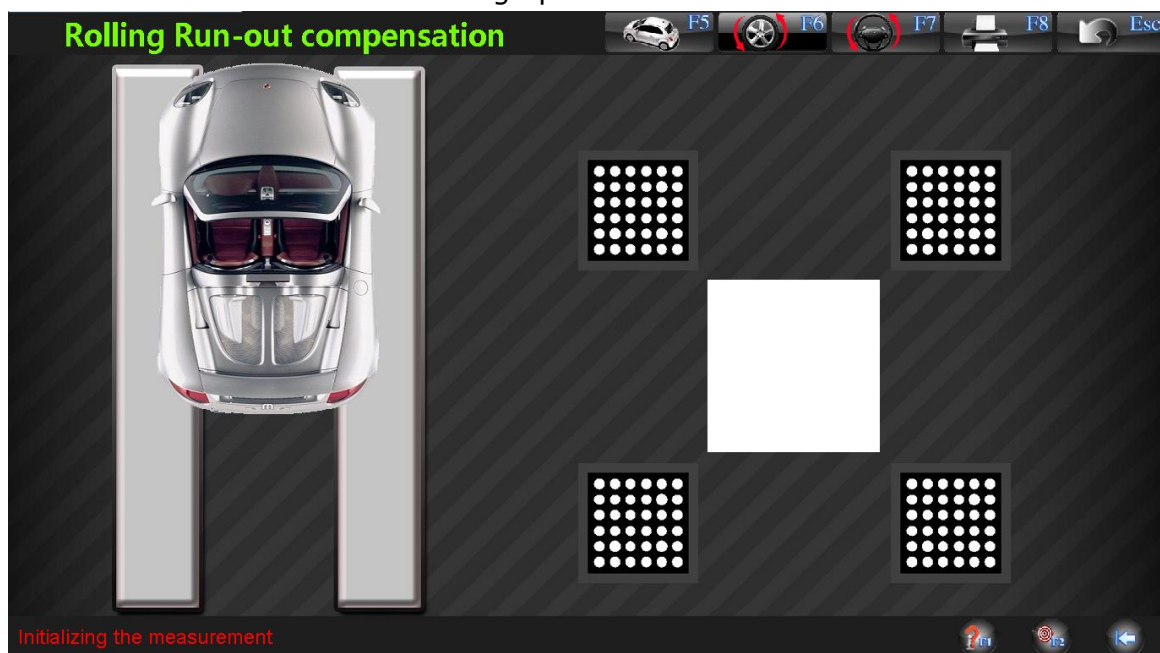

Figure 4. 3

Operation instruction:

1. Mount the clamps and targets.
2. Place the passing bridge.
3. Center steering wheel, lock the steering wheel, and remove brake pedal depressor.
4. Push the vehicle back and forward as instructed by the screen.

Caution

1. **Before push compensation, the steering wheel shall be well locked, otherwise, the wheel will not be stable when do push compensation, and this will cause inaccurate result of push compensation.**
2. **When push vehicle back and forward, shall not block the camera view.**
3. **Make sure the pushing is steady and stable.**
4. **The target initial position shall be vertical to the ground, otherwise, might make the target tilting angle too big and cause error.**
5. **Remove passing bridge when compensation finished.**

[Target red color status]

Indicate the captured image is not applicable for measurement; possible reason shall be blockage between camera and target.

[Help Information]

Help system and tips for the current page.

[Target Monitor]

Can find out the reason in target monitor screen when system prompt target blocked. Also, can adjust the lateral beam height manually in this screen.

[Previous]

Return to the previous step to do rolling compensation again.

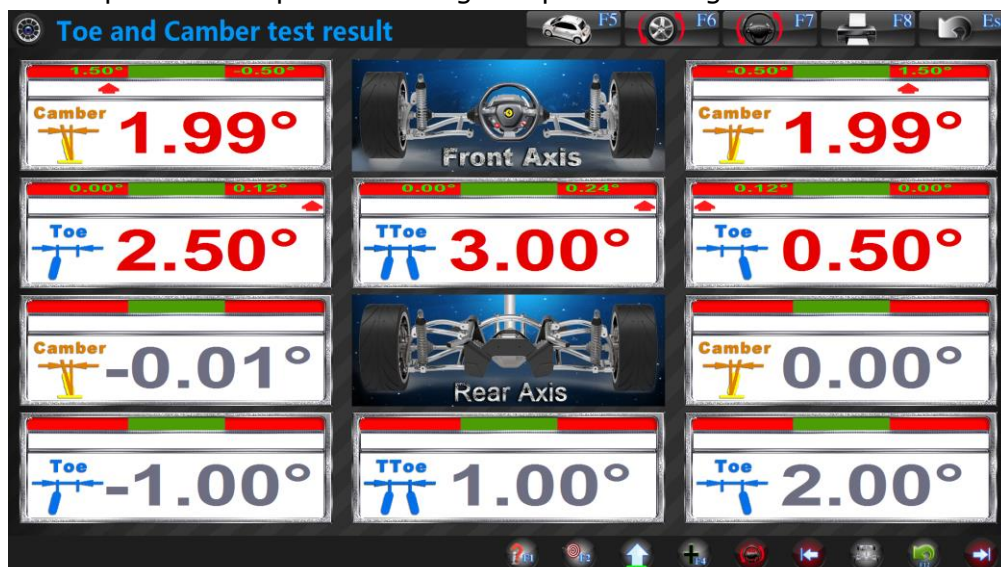

Figure 4. 4

The screen will display real time toe, camber of each wheel after push compensation. Can adjust the vehicle at this page, if caster swing is not considered important. when do adjustment, there might be requirement of lifting the vehicle up or lower the vehicle down, can operate the lift and the lateral beam will follow the lift movement to raise up or lower down. (this feature only applicable on auto focus model)

4.2.1.3 Caster Swing

Caster Swing is only for front wheels, including Caster and SAI. The right SAI value can keep the weight load even on both wheels, protect the axis from damage, and smooth steering. Caster generate a force to keep the front wheel go straight.

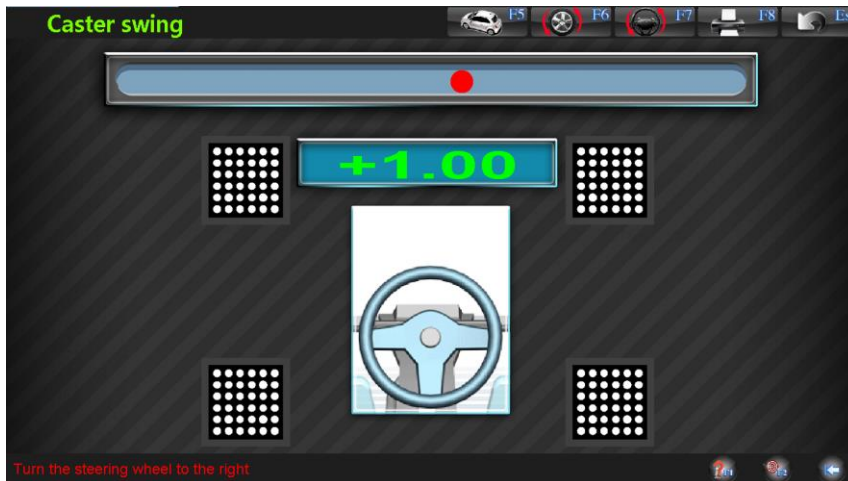

Figure 4. 5

Operation instruction:

1. Turn the steering wheel to make the wheel straight, prompt arrow will display on the screen.
 2. Turn the steering wheel to the right as instructed by the screen.
 3. Turn the steering wheel to the left as instructed by the screen.
 4. Turn the steering wheel back till the indication ball turns from red to green.
- After calculation, the system will automatically prompt the result page, as shown below:



Figure 4. 6

Can adjust the vehicle at this page. when do adjustment, there might be requirement of lifting the vehicle up or lower the vehicle down, can operate the lift and the lateral beam will follow the lift movement to raise up or lower down. (this feature only applicable on auto focus model)

[Additional Measurement] Can measure track width, wheelbase, etc. as shown below:

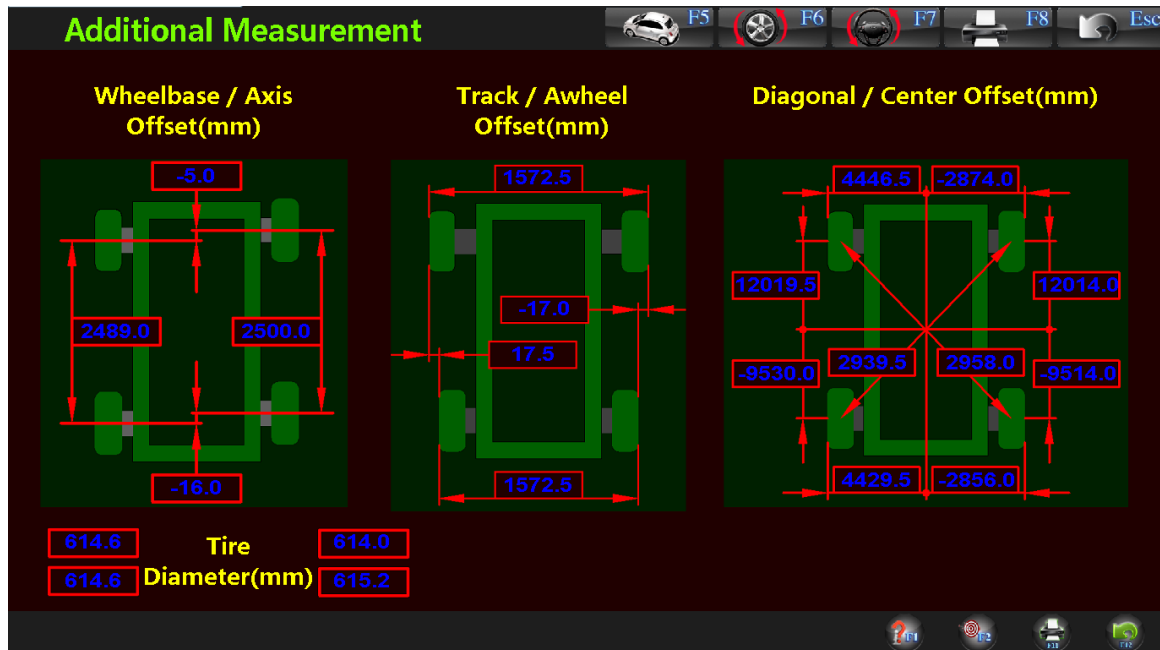

Figure 4. 7

Caution:

1. Before Caster Swing, be sure to mount the brake pedal depressor and remove the steering wheel holder.
2. At each measurement result page, the measurement result is displayed with different color.
 - 1) Green: Value within standard range (OEM specs Min. ~Max. Range)
 - 2) Bright orange: Value exceeded standard range (OEM specs Min. ~Max. Range)
 - 3) White: No reference value available.

4.2.1.4 Print Report

Report Print can print the measurement report and save the data into measurement history database. As shown in the screenshot below:

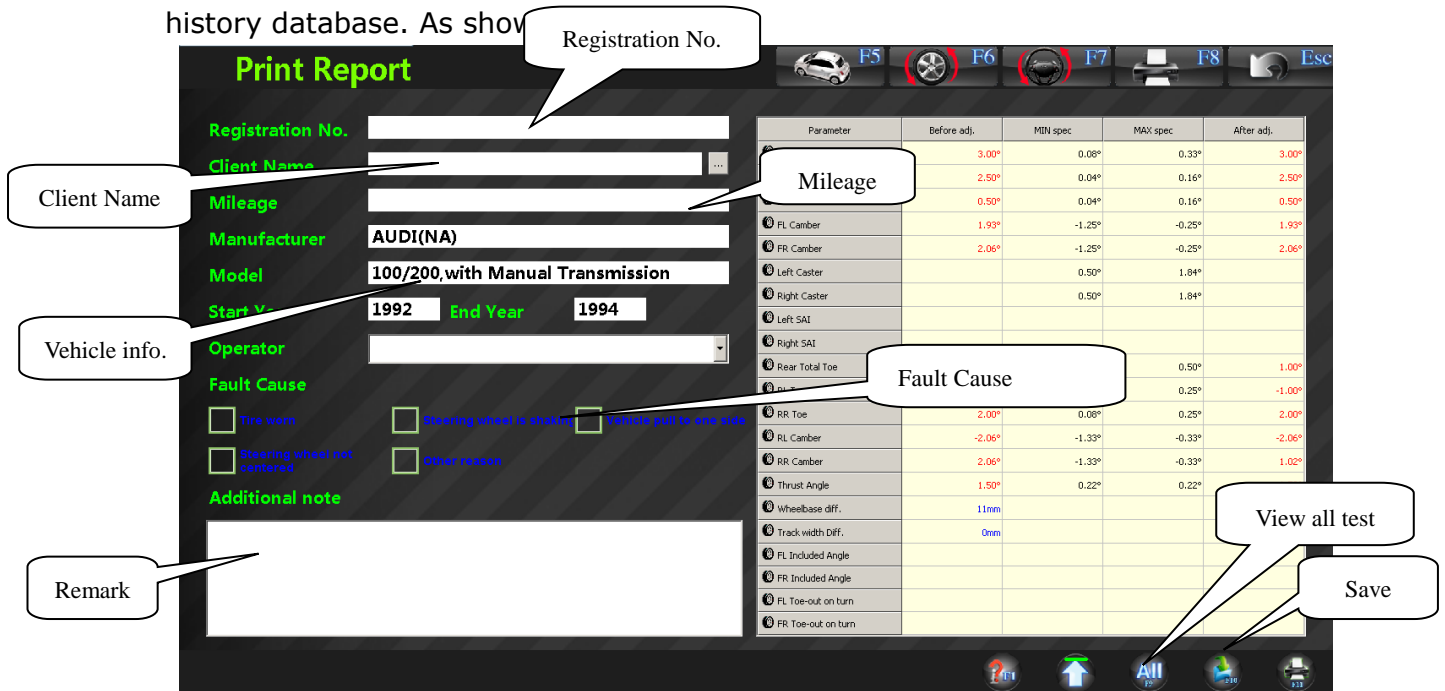

Figure 4. 8

[License No.]: License No. of the tested vehicle.

[Client Name]: The related information of the vehicle owner. Client Information could be inputted directly with keyboard at this page.

[Vehicle info.]: The related information of the current vehicle, including mileage, manufacturer, model, start year, end year. Vehicle information cannot input with keyboard at this page, if a vehicle model is selected beforehand, the corresponding vehicle information will be displayed.

[Fault Cause]: Fault of the tested vehicle. Including: tire worn, pull to one side, steering wheel not center, steering wheel shaking, or other cause.

[View all]: can check all tested data of the vehicle.

[Save]: To save the measurement result, license No. shall be inputted.

Caution: The print function on this page is only applicable for the most recent measurement, while for historical report print, has to access [report print] from the main interface.

[Return]: Return to main interface.

4. 2. 2 System Settings

Click [System settings] at main interface to enter system management page. The screen is as follows:



Figure 4. 9

4. 2. 2. 1 Workshop information

Workshop information mainly used to set workshop contact information and operator information. This information will be imported to the report for print out. For data management and track service record.

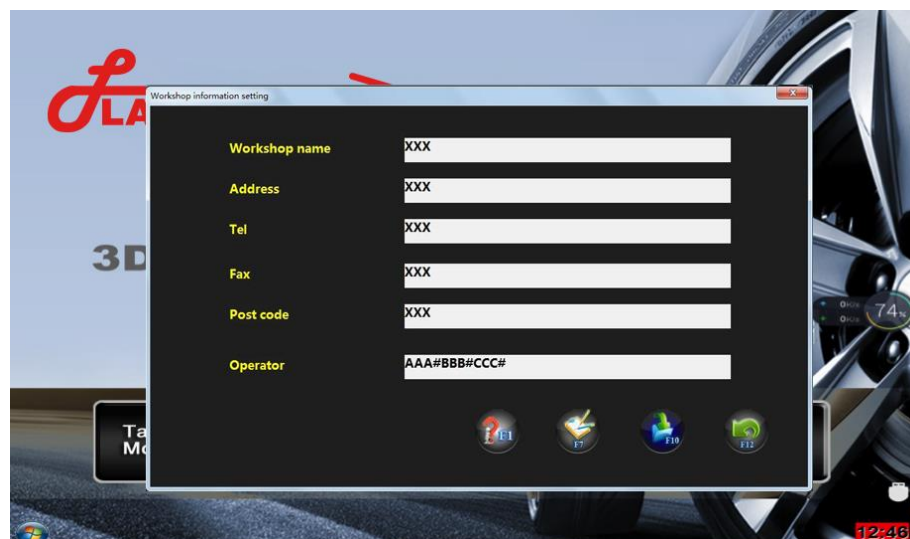

Figure 4. 10

[General Setting]: The content in this page is only editable when click [edit] button. After information edit, the system will save the change and return to the previous page.

Caution: If has more than one operator in the workshop, can use '#' to separate different operator's name. E.g. Adam#Bob#David

4. 2. 2 Client Information

[Client Information] can manage client related information, for better service follow up, the interface is shown below:

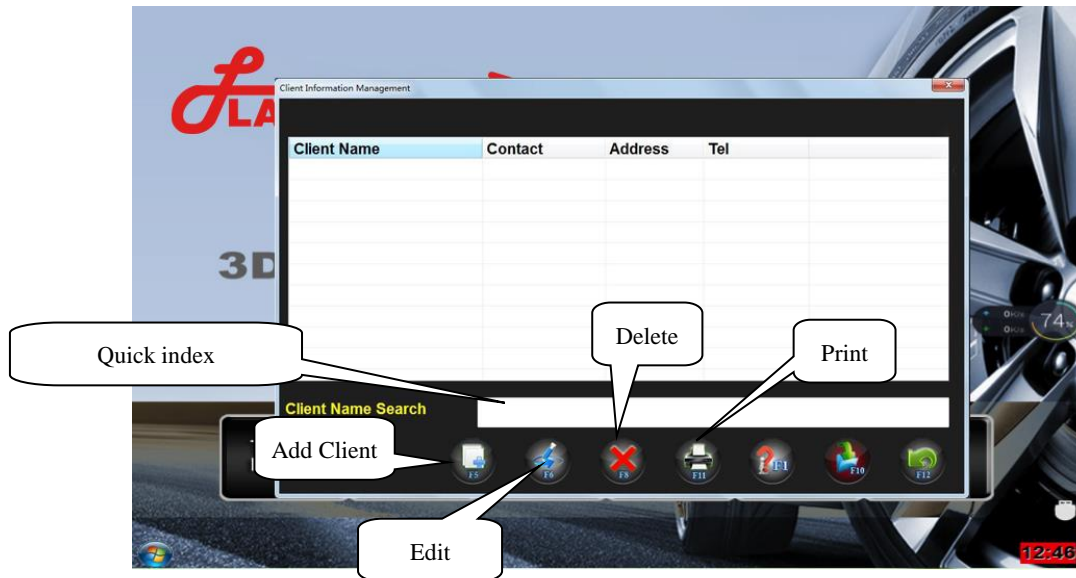

Figure 4. 11

[Quick index] At the bottom of the screen, quick index is provided.

[Add Client]: Click [Add Client], and add client information by fill the form.

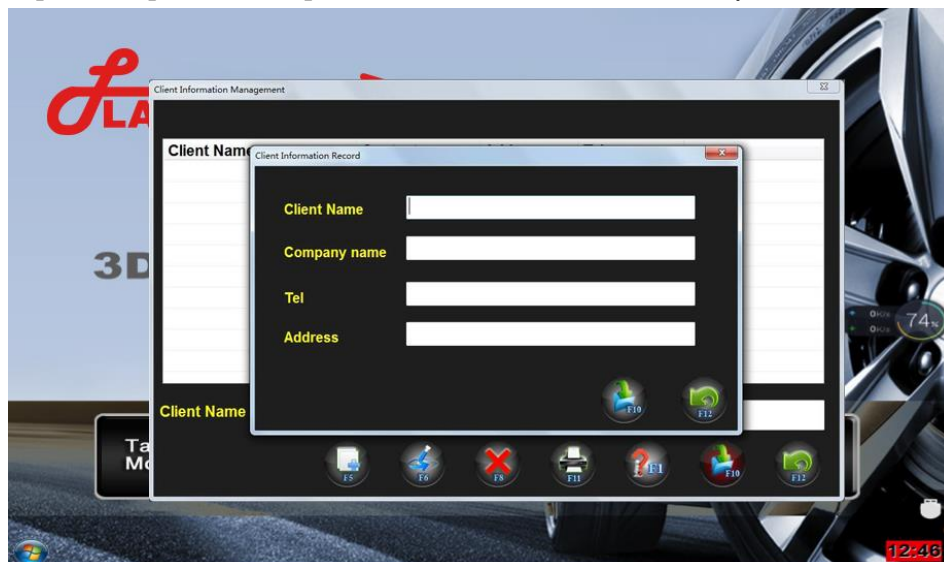

Figure 4. 12

[Edit]: to modify/edit client information.

[Delete]: When delete a client entry, the system will also delete all information including the measurement result of all the vehicles under his name. Please confirm before delete, since the data is not recoverable.

[Print]: to print client list.

4. 2. 2. 3 Language selection

3D series wheel aligner provides various language selections, the screen layout is as follows:

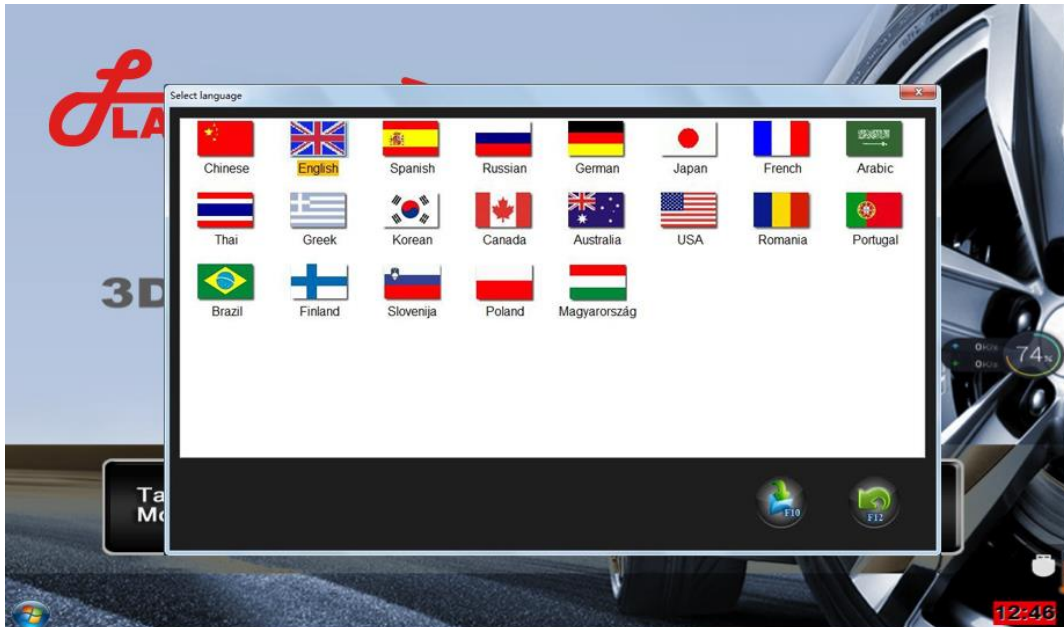

Figure 4. 13

Operation instruction:

Choose wanted language, and then click [OK]. The alignment system will restart with the selected language.

4. 2. 2. 4. OEM specs

This page provides OEM specs of vehicle alignment data when it's manufactured. The database contains as many as possible records for various vehicles, also it provides function to add user defined data into the database, in case some vehicle alignment data is not included in the database. We will provide periodical update after database update; user defined data won't disappear. Screen layout as below:

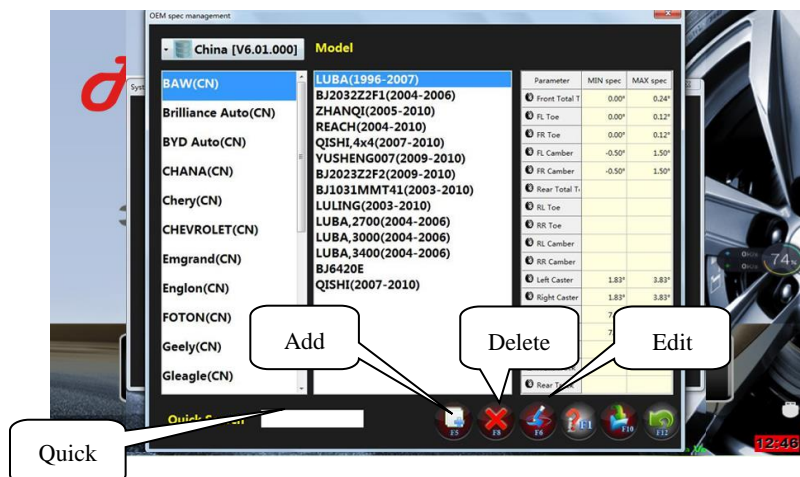

Figure 4. 14

[Quick index]: At the bottom of the screen, quick index is provided.

[Add New]: To add vehicle data which not listed in the standard database, click this button, and add detailed specs on the prompted window. Inputted data will be stored in standard database after confirmation. Layout shown as below:



Figure 4. 15

[Edit]: The edit/modify function only applicable for user defined data, while the OEM specs are fixed, cannot be modified or delete.

[Delete]: The edit/modify function only applicable for user defined data, while the OEM specs are fixed, cannot be modified or delete.

Operation instruction:

Select the manufacturer, and the vehicle model to view the standard specs of the vehicle.

4. 2. 2. 5 Frequently Used Data Management

Frequently Used Specs management could sort the most often used data out of the standard OEM specs, and reduce time cost of finding the desired vehicle model.

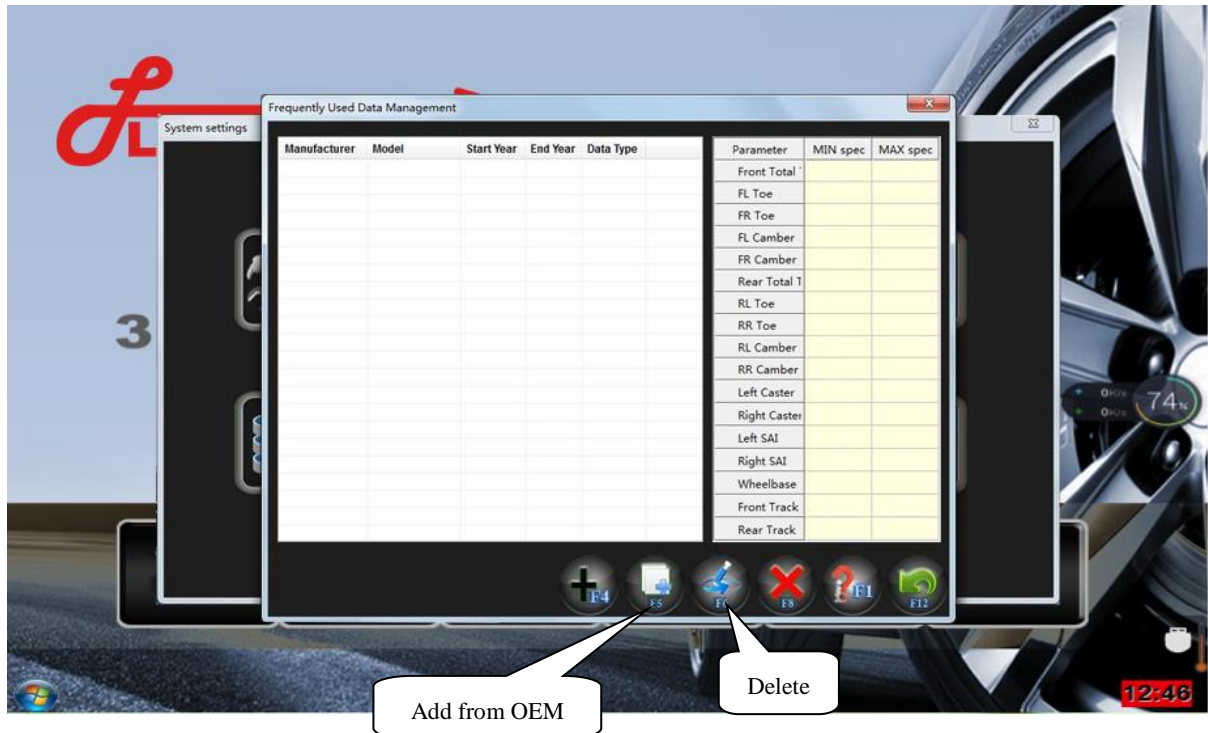

Figure 4. 16

[Add from OEM specs]: to activate the OEM specs list, select desired entry, confirm to add it into frequently used specs.

[Delete]: This function is to delete record in frequently used data.

[Exit]: Return to main interface.

4. 2. 3 General Settings

At main interface to enter [General settings] page. In this page, some change could be made onto the software to suit operator's need.

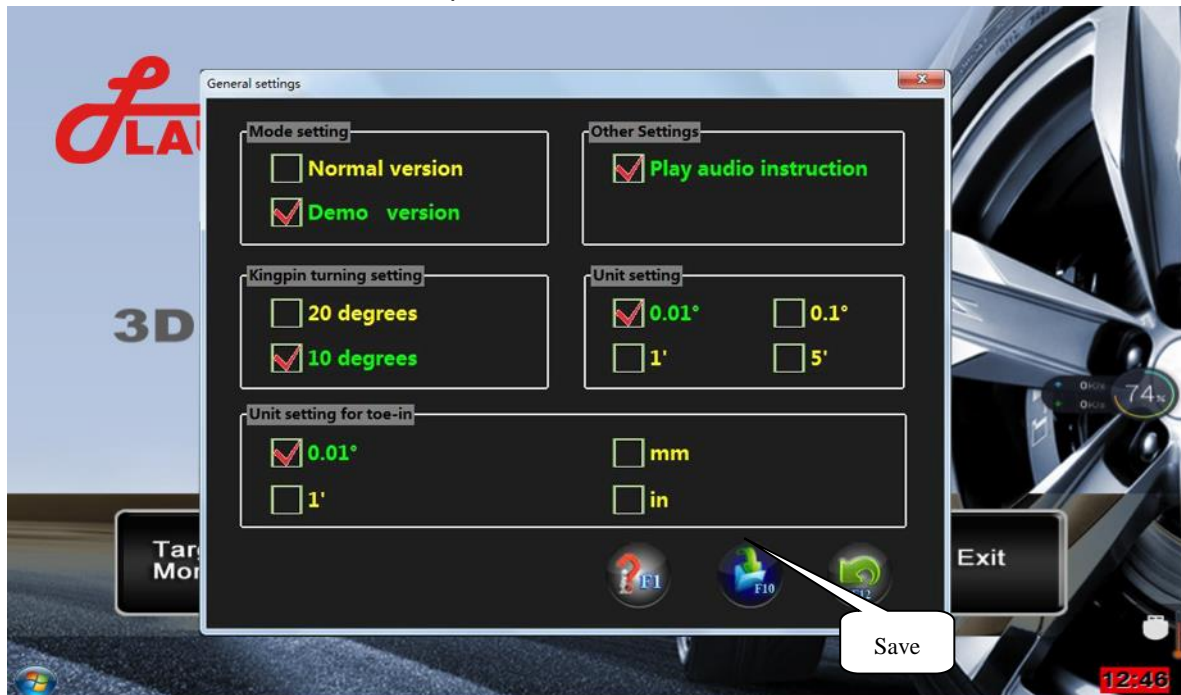

Figure 4. 17

[Client List]: ALL client lists that did alignment measurement.

[Kingpin turning setting]: Select a client entry in the client list will show the service records.

[Print]: Print vehicle alignment data in table format or chart format. (The print format setting please refer to [system management]- [report setting]).

4. 2. 4 Print Report

At main interface, click [Report Print] to enter report page. In this page, operator could navigate or print clients' service record.

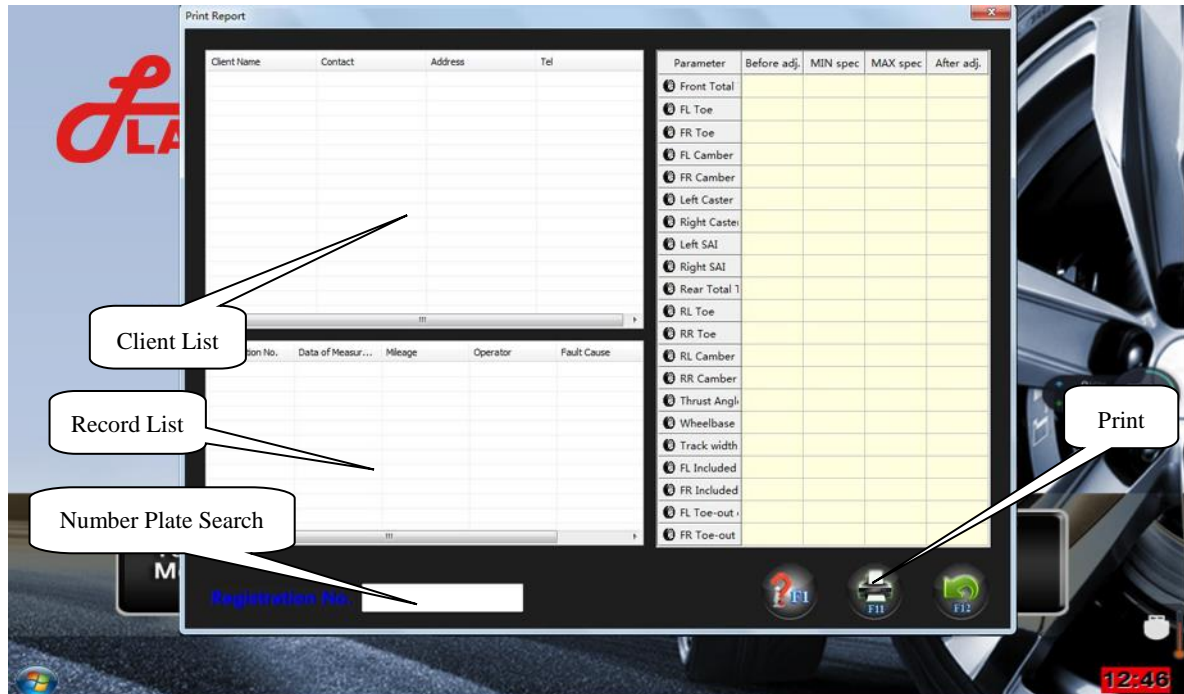

Figure 4. 18

[Client List]: ALL client lists that did alignment measurement.

[Record List]: Select a client entry in the client list will show the service records.

[Number Plate Search]: Can search with the license No. To locate the measurement history of this vehicle.

[Print]: print the measurement report.

4. 2. 5 Help Information

Help system could provide detailed operation instruction:



Figure 4. 19

4. 2. 6 Exit Software

Click to exit Alignment software